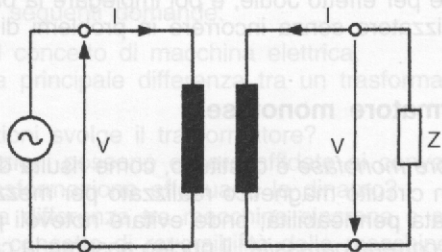
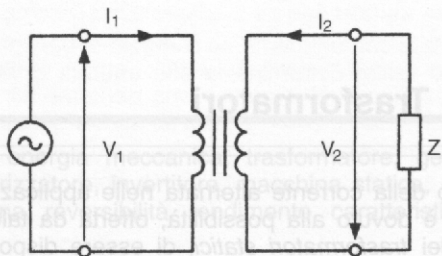
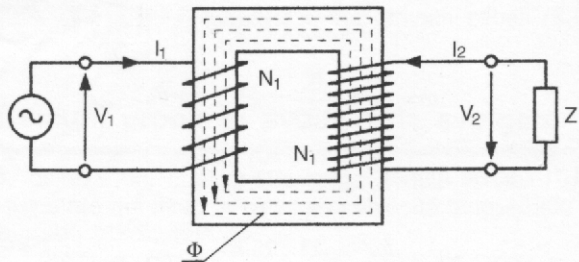
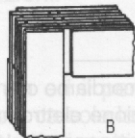
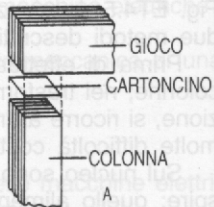
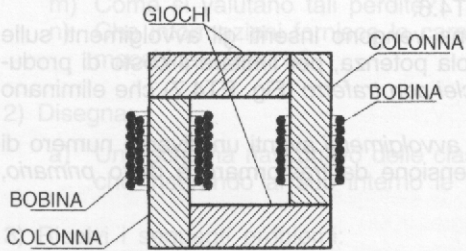
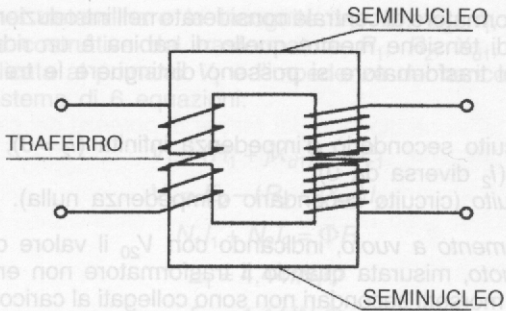

Fig. ET4.1 - Classificazione delle macchine elettriche.





colonne.



$$E_2 = 4,44 N_2 \Phi$$

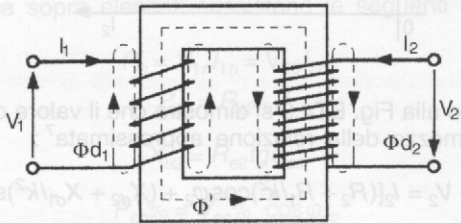

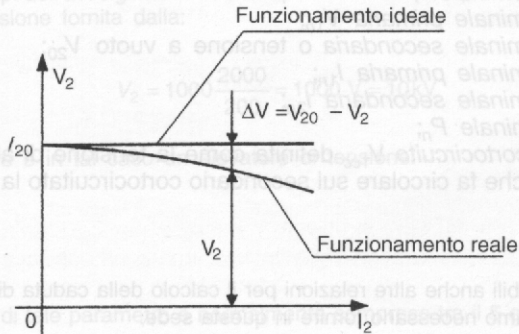

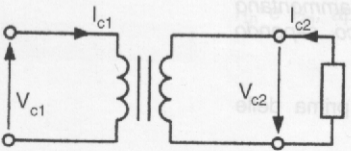
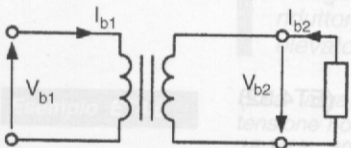
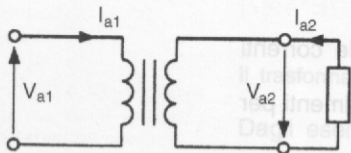

Esempio ET.4.8

SECONDARIO

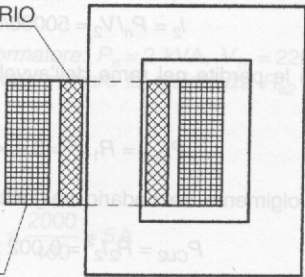

PRIMARIO

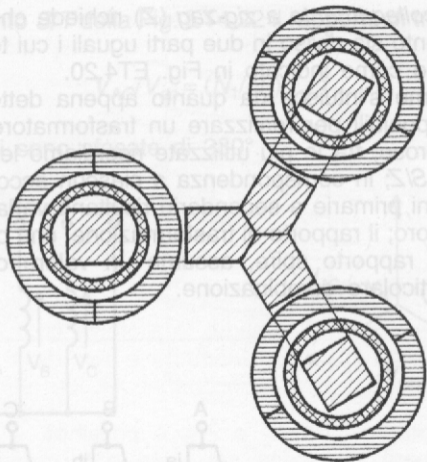

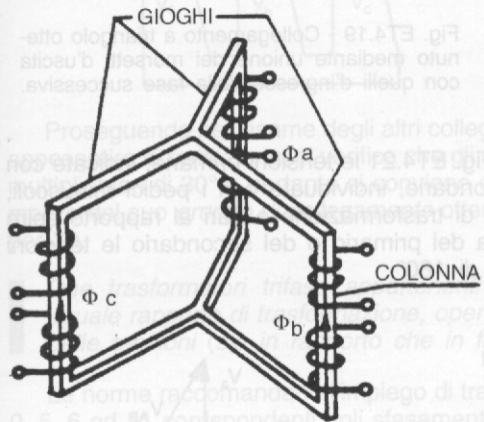

Fig. ET4.14

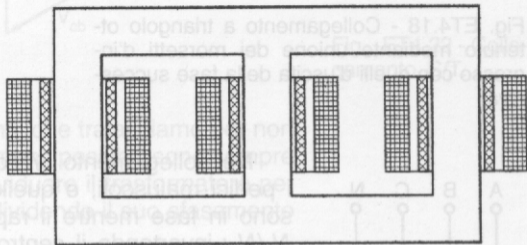
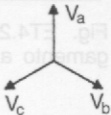
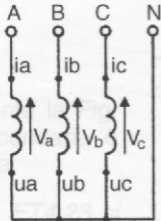
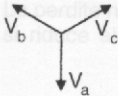
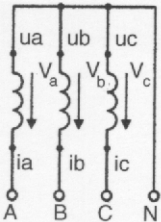

Fig. ET4.15 - Trasformatore trifase a tre colonne complanari.





le perdite nel
pertanto il re

h_{12}

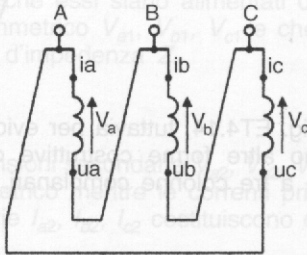
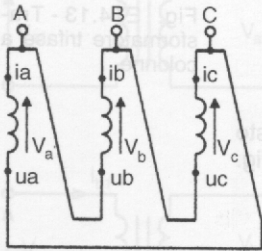

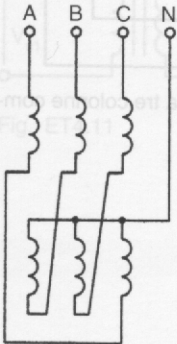

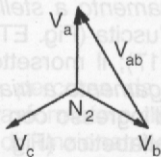
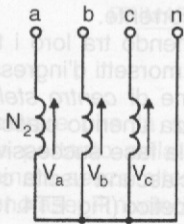
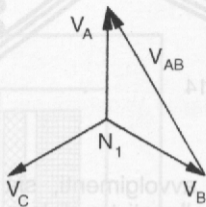
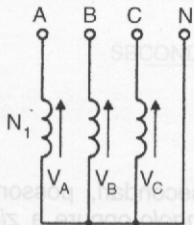

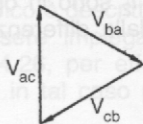
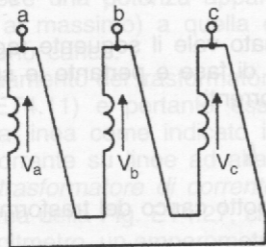
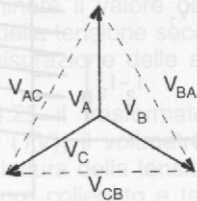
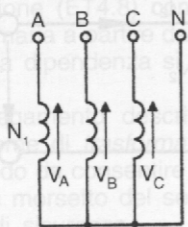

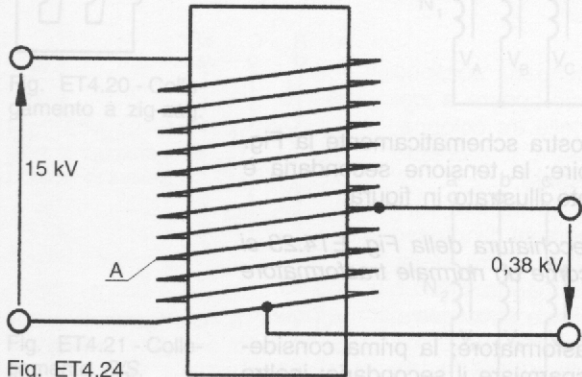
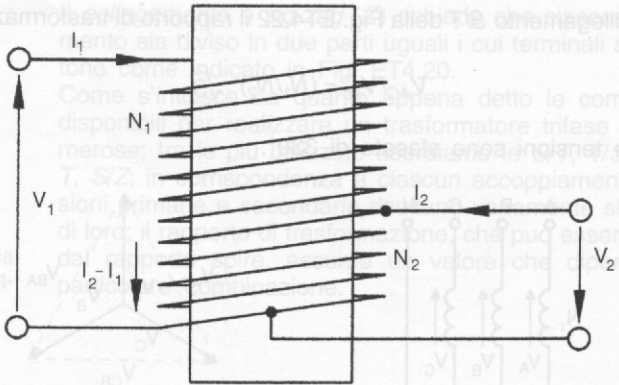

Fig. ET4.24



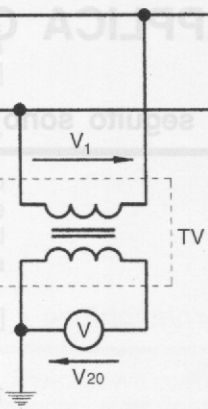

Fig. ET4.25 - Trasformatore di misura TV.

