

filtro/riduttore

O-ring

lubrificatore

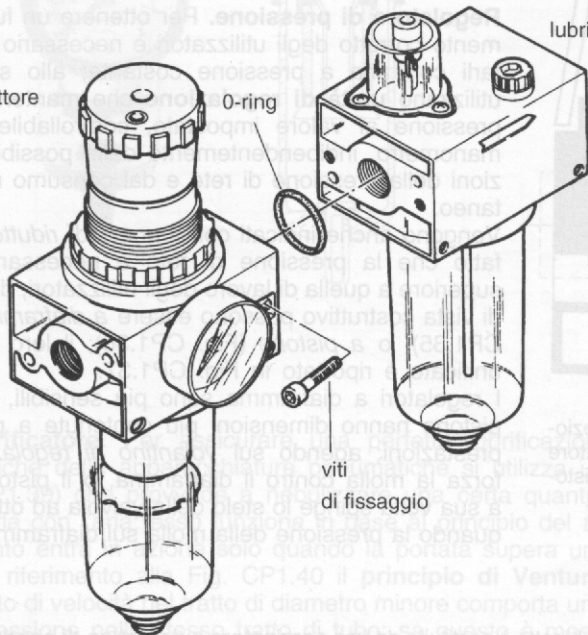

viti
di fissaggio

B

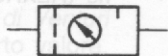

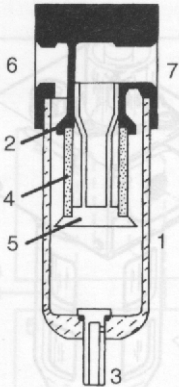

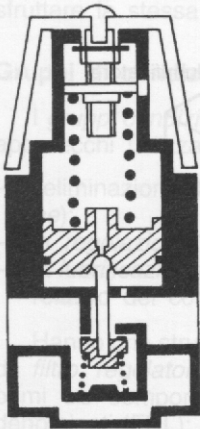
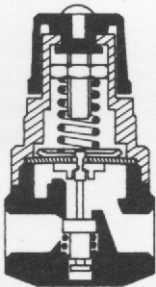

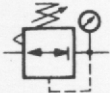

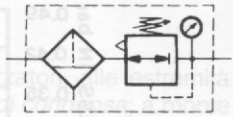
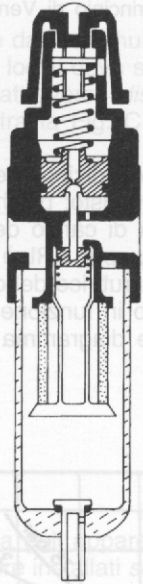
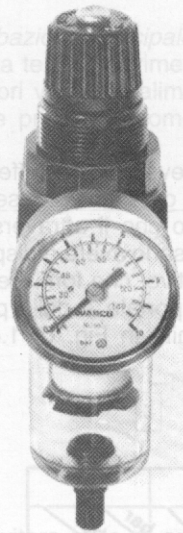

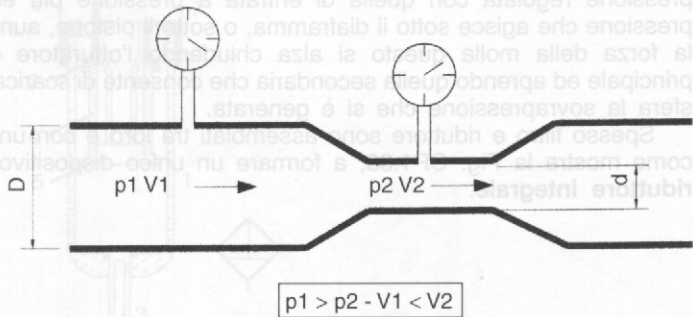
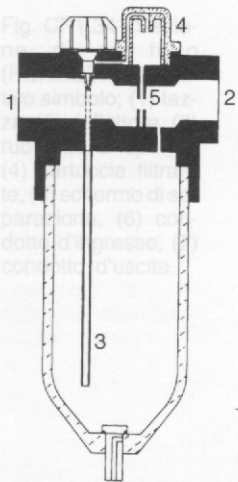
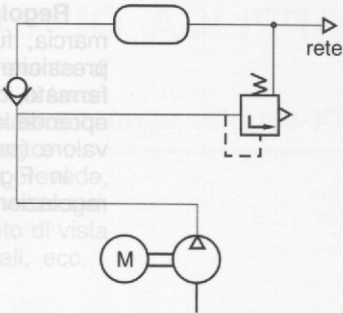

Fig. CP1.40 - Principio di Venturi.



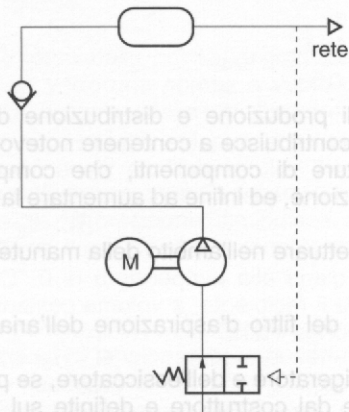

Fig. CP1.48 - Regolazione per chiusura dell'aspirazione.

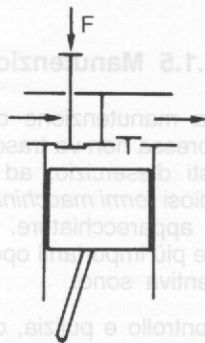

Fig. CP1.49 - Regolazione per apertura della valvola d'aspirazione.

